 WARNING
<p>Keep transmitters and remote controls out of the reach of children. Do not let children play with or use the transmitter or remote controls. Unexpected door operations can cause personal injury or property damage. Do not place transmitter where the buttons can be accidentally or unintentionally activated.</p>



USA & Canada
 (800) 421-1587 & (800) 392-0123
 (760) 438-7000
 Toll Free FAX (800) 468-1340
 www.linearcorp.com

INSTALLATION INSTRUCTIONS FOR MINI TRANSMITTER

**Proper installation of your controls
 will assure years of trouble free operation.
 READ THE FOLLOWING INSTRUCTIONS THOROUGHLY
 BEFORE STARTING INSTALLATION.**

The 9931 Mini Transmitter will operate the same as the standard 9931 transmitter. Both will work with any of our trinary coded receivers. The 9921 Mini Transmitter will operate the same as the standard 9921 transmitter which works with the binary coded receivers.

IMPORTANT: The exact same code must be set on your existing transmitter(s) and your Mini Transmitter. If just one switch is mismatched, the controls will not function. If you are adding the Mini Transmitter to your existing controls, verify the exact code you are currently using on your standard transmitter(s). Reset codes by following the steps below.

CAUTION: EACH MINI TRANSMITTER IS SET TO A FACTORY PRESET CODE. IT MUST BE CHANGED TO SAFEGUARD AGAINST UNAUTHORIZED OR UNWANTED OPERATION. DO NOT SET YOUR EXISTING TRANSMITTER(S) TO THE FACTORY CODE OF THE MINI TRANSMITTER.

LINEAR LIMITED WARRANTY

This product is warranted to the consumer against defects in material and workmanship for one year from the date of purchase. This warranty applies to first retail buyers of new devices. Warrantor will repair, or at its option, replace, any device it finds that requires service under this warranty, and will return the repaired or replaced device to the consumer at the warrantor's cost. For warrant service and shipping instructions contact warrantor at the address shown below. Devices must be sent to warrantor for service at owner's expense. The remedies provided by this warranty are exclusive. Implied warranties under state law are to the one year period of this written warranty. Some states do not allow limitations on how long an implied warranty lasts, so the above limitation may not apply to you. In order to be protected by this warranty, save your proof of purchase and send copy with equipment should repair be required. This warranty gives you specific legal rights, and you may also have other rights which vary from state to state.

For warranty service and shipping instructions contact Linear at the phone number shown below. In order to be protected by this warranty, save your proof of purchase and send a copy with equipment should repair be required. All products returned for warranty service require a Return Product Authorization Number (RPA#). Contact Linear Technical Services at 1-800-421-1587 for an RPA# and other important details.

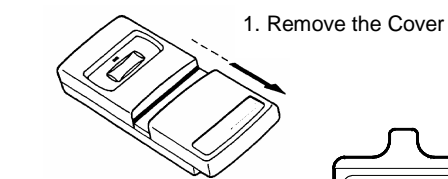

2. Remove the Phillips Screw

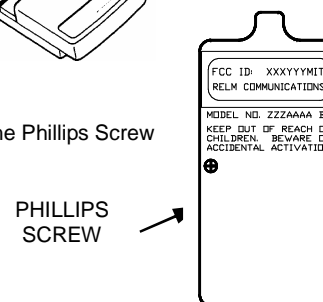

1. If you are currently using a standard 9931 or 9921 transmitter, you can remove the access cover from the front of the transmitter by sliding the cover away from the top of the transmitter.
2. Remove the screw from the back of the Mini Transmitter with a small phillips screwdriver. Lay the transmitter down with the button facing up. Unsnap the top of the transmitter to access the coding switches.
3. Model 9931: The coding switch in this model consists of nine switches, each of which can be placed in three different positions, "+", "0", "-".

 WARNING	<p>Radio Controls are prohibited from providing constant contact closure when installed on the push button inputs of residential garage door openers that are provided with monitored safety systems.</p>
--	---

Use a small screwdriver to set the nine coding switches in the Mini Transmitter(s) to exactly match your existing transmitter(s). This is your private code setting. **DO NOT SET ALL THE SWITCHES IN THE SAME POSITIONS**

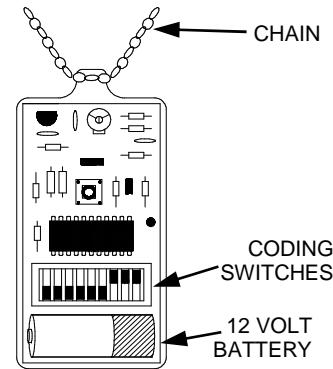
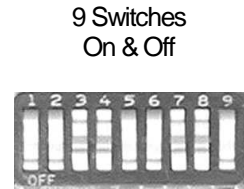
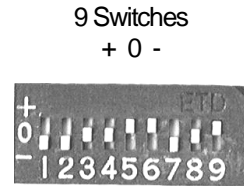

IMPORTANT
The SAME CODE must be set on both the transmitter and receiver.
The controls will not function if the codes are mismatched.

4. Model 9921: The coding switch in this model consists of nine switches, each of which can be placed in two different positions, ON or OFF. Using a small screwdriver, push the red dot on the rocker switch to set each ON or OFF. Set the coding switch to the exact code as the existing transmitter(s). This is your private code. **DO NOT SET ALL SWITCHES IN THE SAME POSITION.**
5. Do not replace the cover on the transmitter(s) until the identical code has been set in all your transmitters. When you are sure that all the switches are set the same, slide the access door of your existing transmitter(s) back in place. Put the top back on the Mini Transmitter and tighten the phillips screw. Remember to place the necklace chain or key ring in the eye of the transmitter case before you snap the transmitter back together.
6. When replacing the Mini Transmitter battery, open the case as described previously. Remove the old battery and replace it with a 12 volt Alkaline Lighter battery #A23, A23M MN21 or its equivalent. Be sure that the "+" terminal of the battery is in the correct position as marked in the transmitter case. Replace the top and chain or key ring and tighten the phillips screw. After replacing the battery, be sure to test the transmitter.
7. If your Mini Transmitter(s) is part of a new set of controls, refer to installation Instructions for Radio Controls, Step 1: SET YOUR CODING SWITCHES. After opening the Mini Transmitter as described previously, set your Mini Transmitter switches the same as the Receiver switches.

Learning Transmitter Codes using MVP Receiver

The MVP receiver is capable of learning up to 8 different transmitter codes. The transmitters may be any combination of MVP, Classic or Original dip-switch type transmitters.

Programming One Door Receivers

- Step 1:** Momentarily press and release the Learn button. The LED will turn on.
- Step 2:** Using a programmed transmitter, press the desired transmitter button. When the receiver learns the transmitter code, the LED will turn off.
- Step 3:** Repeat to add additional transmitters with different codes.

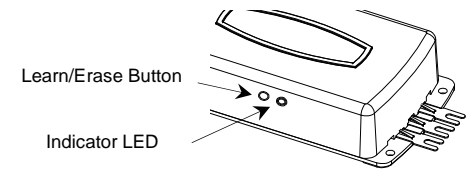

CHECK OUT YOUR DOOR OPERATING SYSTEM

CAUTION: THERE ARE NO USER SERVICEABLE PARTS INSIDE TRANSMITTER OR RECEIVER

- A. After installing your transmitter, check the operation of your radio controls by moving approximately 35 feet back from the garage door, then press the transmitter button. Operation at this distance should be reliable.
 - B. If the transmitter doesn't activate the operator, check the coding switches on both the transmitter and receiver to assure an "exact" match. This may necessitate a reprogramming of the transmitter to match the receiver coding switches.
 - C. If the distance is inadequate, check the battery and replace if necessary.
 - D. To maximize the operating distance move the transmitter to different locations in the car until a satisfactory distance is achieved.
 - E. If the receiver is in the proximity of a metal beam or other obstruction it may be necessary to relocate the receiver to increase the operating range.
 - F. **If multiple receivers are mounted closer than 15 feet, blocking and interference may occur. Relocate the receivers farther apart.**
- If system does not work at any distance, check that the receiver terminals are connected to the proper operator terminals.

The Mini Transmitter is **NOT WATERPROOF.**

If the Mini Transmitter gets wet, operations will be impaired.