

DT-4B

DIGITAL TRANSMITTER

Code Setting Instructions

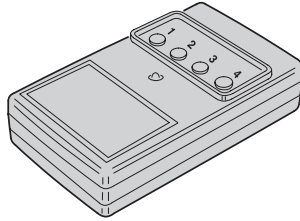

Linear®

(800) 421-1587 • www.linearcorp.com



DESCRIPTION The Delta-3 DT-4B digital transmitter is a four-channel wireless radio control designed for use with automatic garage/gate operators and access control systems. The transmitter can be used with one four-channel receiver (DR4), two two-channel receivers (DR2) or four single-channel receivers (DR, DRQ or DRM). **Receivers should be mounted at least 8 feet apart.**

The Delta-3 radio format provides 256 different digital codes. The codes are set using the 8-position coding switches in the units.

*** CAUTION: All transmitters and receivers should be recoded by the installer prior to operation.**

In order to avoid the possibility of duplicating codes in adjacent systems, factory set codes should not be used. In addition, among the valid codes available, four others should not be used. These include: all keys set ON or OFF and keys set alternating ON/OFF.

The transmitter is powered by a 9-volt battery. It should last 12 to 18 months with normal use. The red LED on the face of the transmitter will glow when the unit is activated. When it lights dimly, or not at all when transmitting, the battery needs to be replaced.

STEP 1 Locate coding switch. Remove the battery access door located on the back of the transmitter case. Identify the coding switch and note that it has eight positions, with ON and OFF clearly labeled.

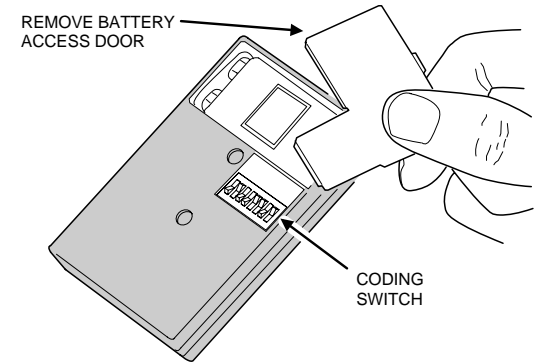

STEP 2A Coding for single-channel receivers. Pick any combination of OFF/ON codes and set them on switch keys 3-8 in the transmitter. Match the same code on switch keys 3-8 in each receiver. Set each receiver's switch keys 1 and 2 to select which transmitter button will activate it. **Transmitter switch keys 1 & 2 are unused and can be in any position.**

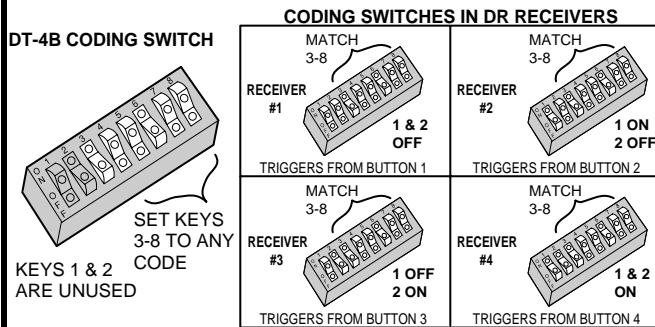

STEP 2B Coding for two-channel receivers. Pick any combination of OFF/ON codes and set them on switch keys 3-8 in the transmitter. Match the same code on switch keys 3-8 in each receiver. Set each receiver's switch key 2 to select which transmitter buttons (1 & 2, or 3 & 4) will activate it. **Transmitter switch keys 1 & 2 and receiver switch key 1 are unused and can be in any position.**

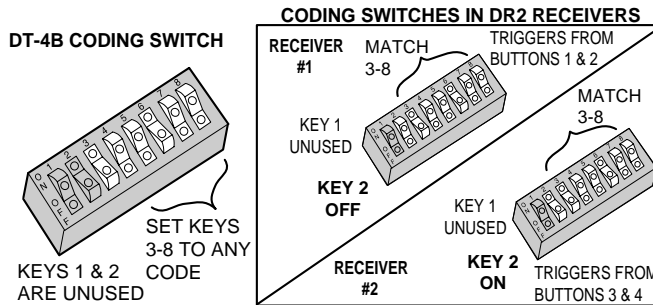

STEP 2C Coding for a four-channel receiver. Pick any combination of OFF/ON codes and set them on switch keys 3-8 in the transmitter. Match the same code on switch keys 3-8 in each receiver. **Transmitter and receiver switch keys 1 & 2 are unused and can be in any position.**

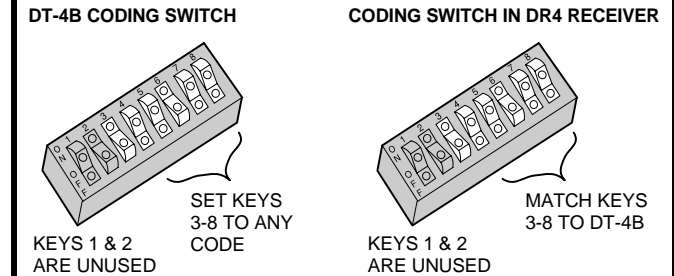

STEP 3 Test the equipment. Connect the receiver(s) to the operators as described in the receiver's installation instructions. **Be sure the door/gate area is clear.** Activate the transmitter and verify that the receiver triggers the operator. Check that the correct button on the DT-4B activates the desired operator.

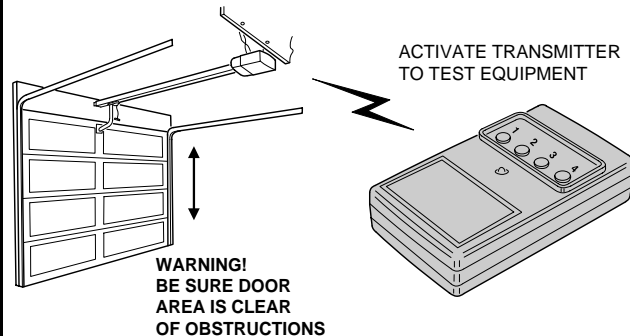

BATTERY REPLACEMENT

The battery should last 12 to 18 months with normal use. The red LED on the face of the transmitter will glow when the unit is activated. When the red LED lights dimly, or not at all when transmitting, the battery needs to be replaced. Remove the battery access door to change the battery. Any type of 9-volt battery can be used.

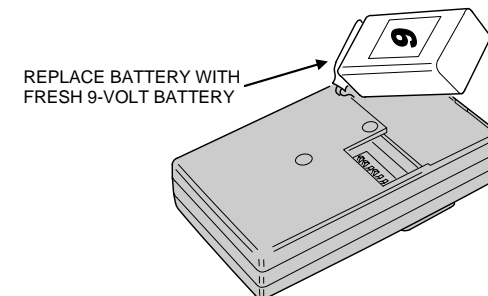

LINEAR LIMITED WARRANTY

This product is warranted to the consumer against defects in material and workmanship for one year from the date of purchase. This warranty applies to first retail buyers of new devices. Warrantor will repair, or at its option, replace, any device it finds that requires service under this warranty, and will return the repaired or replaced device to the consumer at the warrantor's cost. For warranty service and shipping instructions contact warrantor at the address shown below. Devices must be sent to warrantor for service at owner's expense. The remedies provided by this warranty are exclusive. Implied warranties under state law are to the one year period of this written warranty. Some states do not allow limitations on how long an implied warranty lasts, so the above limitation may not apply to you. In order to be protected by this warranty, save your proof of purchase and send copy with equipment should repair be required. This warranty gives you specific legal rights, and you may also have other rights which vary from state to state.

All products returned for warranty service require a Return Product Authorization Number (RPA#). Contact Linear Technical Services at 1-800-421-1587 for an RPA# and other important details.

IMPORTANT !!!

Linear radio controls provide a reliable communications link and fill an important need in portable wireless signaling. However, there are some limitations which must be observed.

- * For U.S. installations only: The radios are required to comply with FCC Rules and Regulations as Part 15 devices. As such, they have limited transmitter power and therefore limited range.
- * A receiver cannot respond to more than one transmitted signal at a time and may be blocked by radio signals that occur on or near their operating frequencies, regardless of code settings.
- * Changes or modifications to the device may void FCC compliance.
- * Infrequently used radio links should be tested regularly to protect against undetected interference or fault.
- * A general knowledge of radio and its vagaries should be gained prior to acting as a wholesale distributor or dealer, and these facts should be communicated to the ultimate users.

This device complies with FCC Rules Part 15. Operation is subject to the following two conditions: (1) This device may not cause harmful interference and (2) this device must accept any interference received, including interference that may cause undesired operation.