

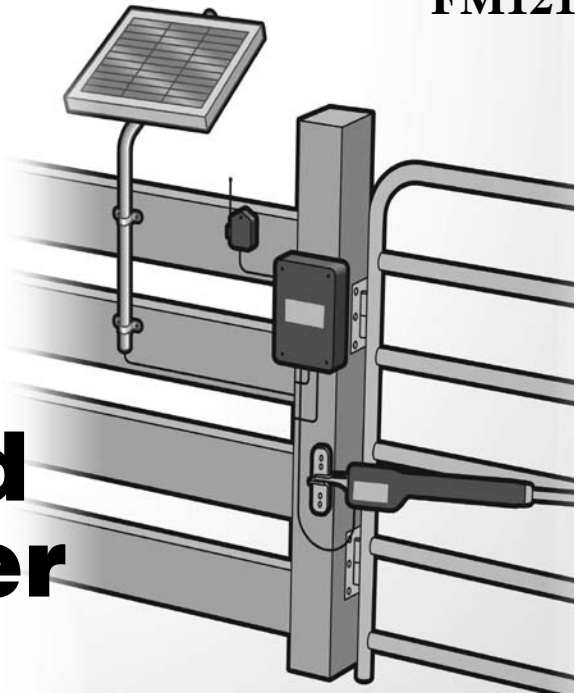

FM121

5 Watt

Solar Powered Battery Charger Installation Manual



Compatible with all Mighty Mule and GTO/PRO DC Powered Slide and Swing Gate Operators except for the Mighty Mule 250 (FM250).

All dual gate installations require a minimum of 10 Watts of solar charging power.

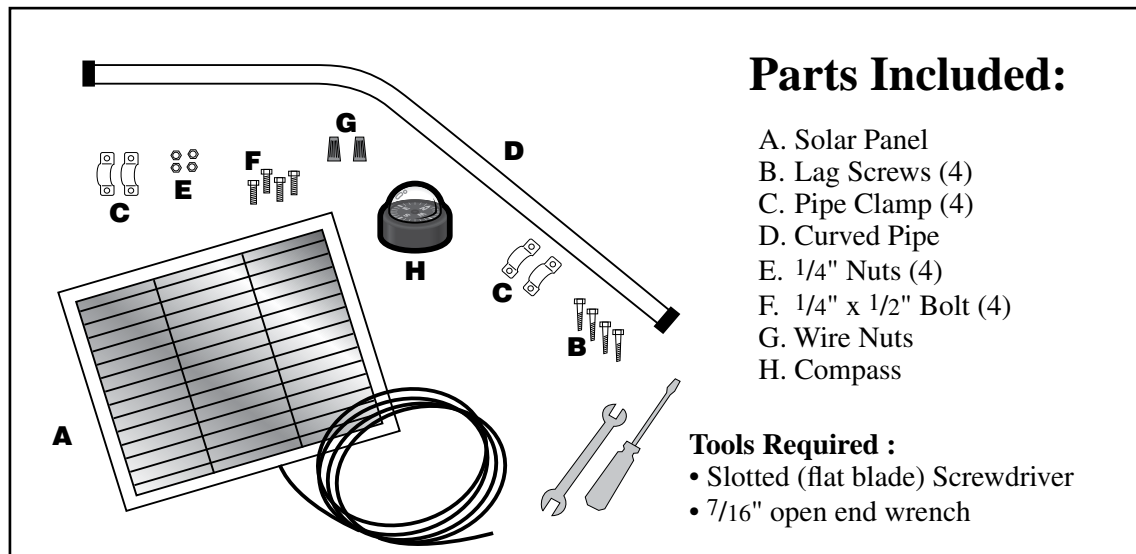

For more information on Mighty Mule's full line of automatic gate openers and access controls visit our website at www.mightymule.com

Solar Panel Installation

Step 1: Slide the 1/4" bolts (F) through the bottom of each channel so threaded part of each bolt comes through top of frame, position the pipe (D) between the bolts and place two clamps (C) over the curved pipe onto the bolts. The clamp at the top of the solar panel should fit over the pin on the curved pipe. Secure with the 1/4" nuts (E).

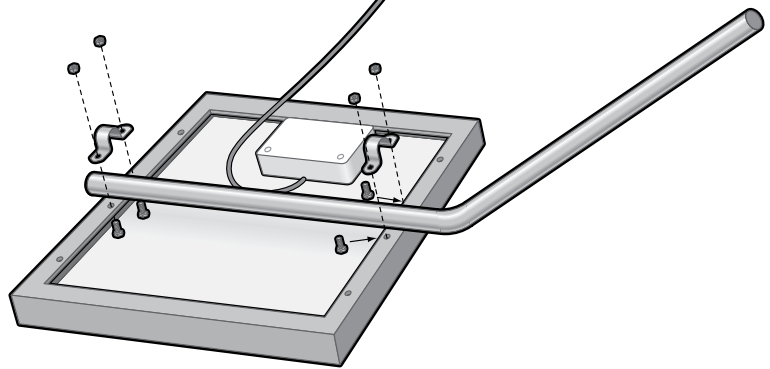
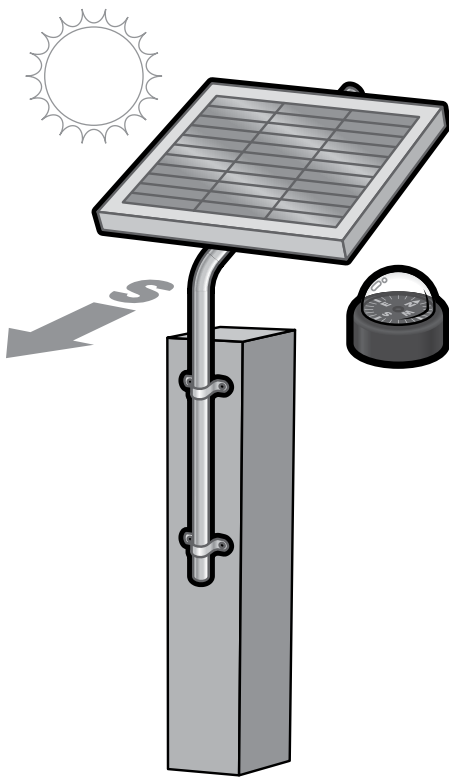

Step 2: Determine the site for installation of the solar panel. It is important to install the solar panel **facing the path of the sun** where full sun will strike its face throughout the day. **The solar panel cannot be shaded out or obstructed by trees, bushes, buildings etc for any part of the day.** The curved pipe (D) maintains the proper angle to the sun. Secure the solar panel assembly to a wooden post or fence using two pipe clamps (C) and #2 lag screws (B) as shown in the illustration. If your fence post is metal, you will need alternative hardware not provided, (i.e. U-clamps or metal screws).

IMPORTANT: the solar panel must be positioned facing the path of the sun, due south and in an open area away from shade. It should receive at least 8 hours of direct sunlight for a full charge.

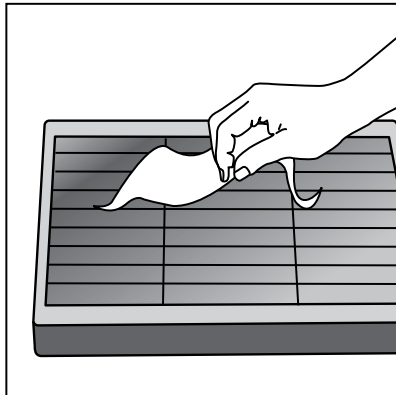

HINT: If the solar panel must be placed more than 10 ft. from the control box (but less than 250 feet away), use multi-stranded, 16 gauge (AWG), direct burial, low-voltage wire RB509 (see Accessory Catalog). **Never use telephone wire or solid core wire.**

IMPORTANT: To provide secure and moisture resistant splices for solar panels use a direct burial splice kit for underground splices and an above ground splice kit for above ground splices. These splice kits can be found at hardware and electrical supply stores.

HINTS for Obtaining Maximum Output from Your Solar Panel

1. Place the panel facing due south in the path of the sun, where full sun will strike its face throughout the day (minimum 8 hours).
2. Mount the panel using the curved pipe provided to maintain the proper angle to the sun.
3. For optimal efficiency, wipe the face of the panel frequently with a soft, damp cloth. The output of the Solar Panel is variable during the day depending on the intensity of the sun and the angle of the rays striking the panel. The output may vary from a few millivolts to as much as 22 volts. To check the output, simply disconnect the solar panel leads from the control board and connect them directly to a dc voltmeter. In bright sunlight the panel output should read at least 18 volts dc at approximately 300mA.

Step 3: All Mighty Mule and GTO/PRO DC powered gate operators have a **POWER IN** terminal on their control boards marked **SOLAR** for connecting the solar panel wires. Below are various types of terminals on GTO/PRO and Mighty Mule control boards, if your control board doesn't have this terminal, please call the GTO's Technical Service Department at (800)543-1236 or (850)575-4144 for assistance.

Feed the free end of the solar panel wires into the control box and attach them to the **SOLAR** terminals on the **POWER IN** terminal block on the control board. The **RED** solar panel wire goes to the (+) **POSITIVE** Solar terminal and the **BLACK** solar panel wire goes to the (-) **NEGATIVE** Solar terminal. See diagram below.

IMPORTANT: Improper installation of these wires will damage to the opener's control board.

Attach **RED** solar panel wire to the **SOLAR** terminal marked (+).

Attach **BLACK** solar panel wire to the **SOLAR** terminal marked (-).

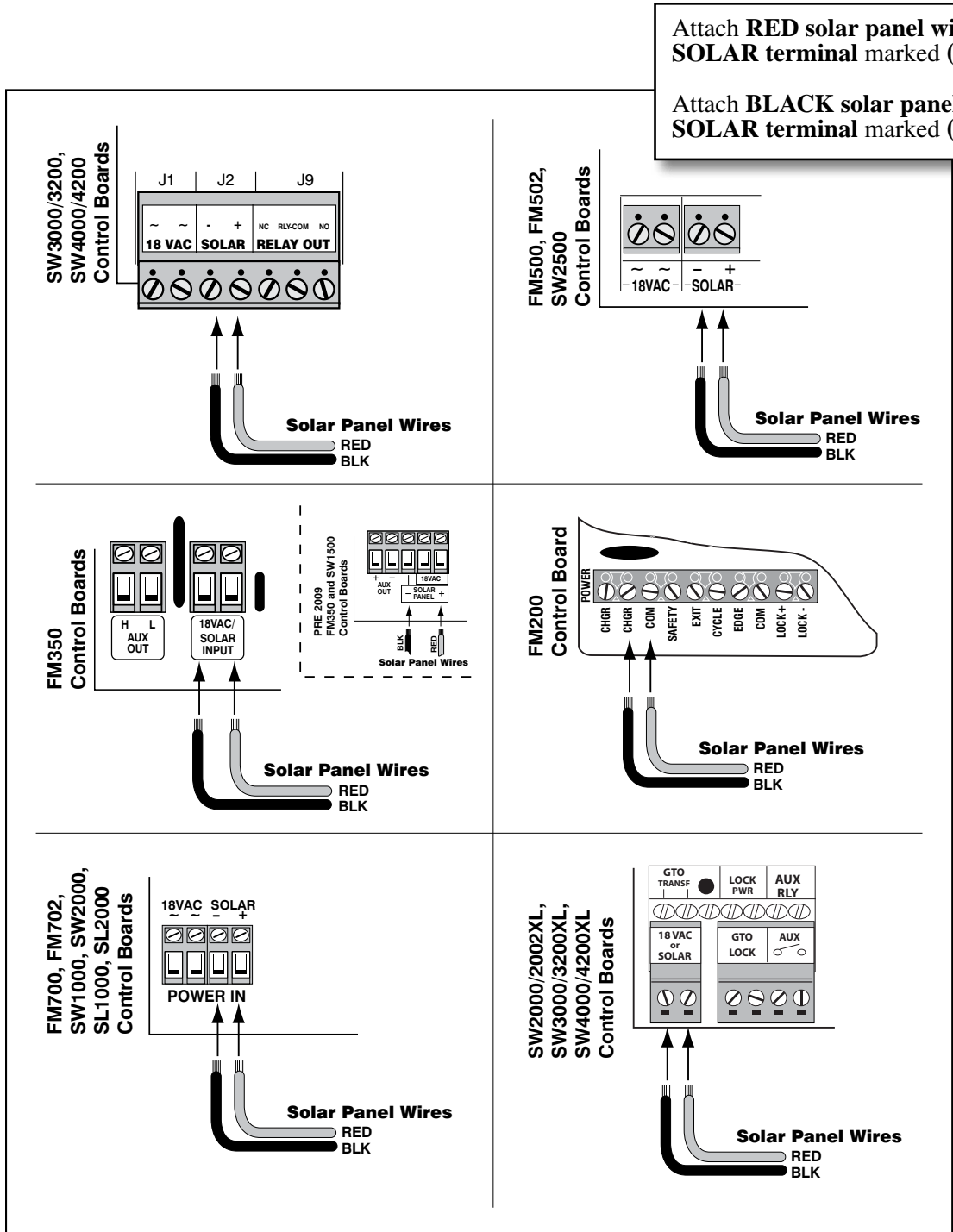

Solar Zones and Gate Activity

Use the table and map to determine the number of operational cycles* per day to expect in your area, using 5 to 30 Watts of charging power. Figures are shown for winter (minimum sunlight) and do not account for the use of any accessory items.

*An operational cycle is one full opening and closing of the gate.

*Number of openings per day will depend on the length, weight, hardware and environmental conditions.

Estimated Gate Openings Per Day

Winter Ratings	Zone 1	Zone 2	Zone 3
Single gate installation with 5 Watts of charging power	4	8	13
Single gate installation with 10 Watts of charging power	8	16	26
Single gate installation with 20 Watts of charging power	14	28	38
Single gate installation with 30 Watts of charging power	20	44	54
Dual gate installation with 10 Watts of charging power	4	8	13
Dual gate installation with 20 Watts of charging power	10	18	27
Dual gate installation with 30 Watts of charging power	16	28	41

All dual gate installations require a minimum of 10 Watts of solar charging power.

Accessories will draw additional power from the battery; the more accessories you connect, the more power your system will require. We recommend that you purchase an extra 12V, 7 amp hour battery (**RB500**) for the FM500/502, SW2000XL/2002XL, SW3000XL/3200XL, SW4000XL/4200XL

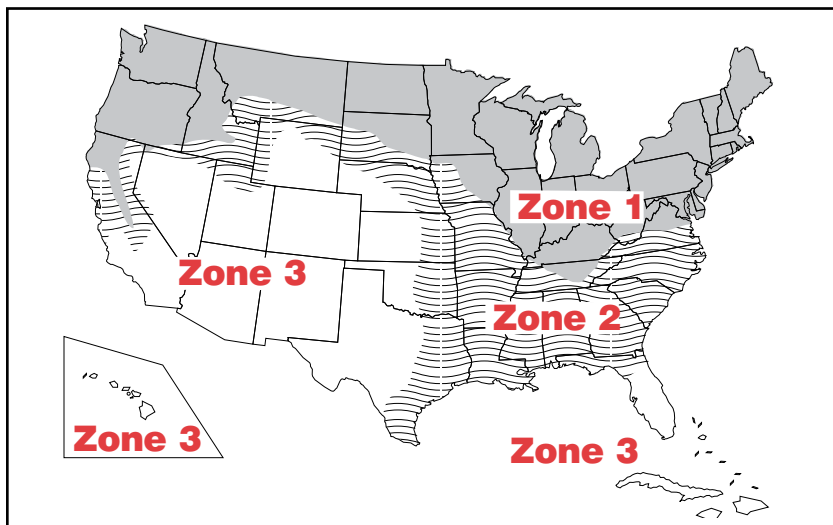

Multiple Panel Installations

NOTE: All connections should be weather proofed using weather proof splice kits available at hardware and electrical supply stores.

Solar Panels connect in PARALLEL

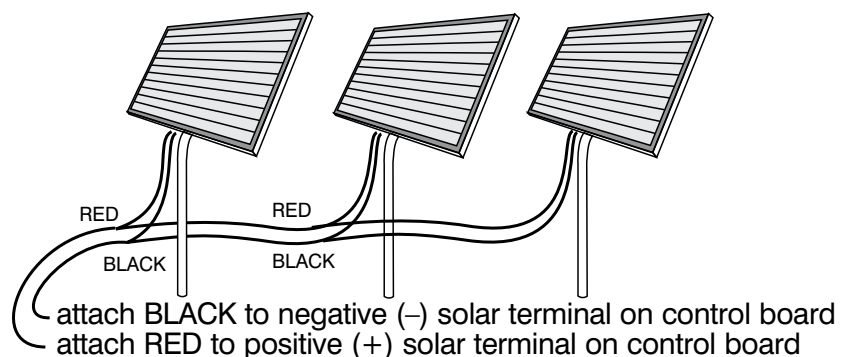

Other Mighty Mule and GTO/PRO Access Controls and Accessories



Push Button Control (FM132)

Unlit doorbell button for remote entry or exit control. Wires directly to the control board and uses 16 gauge multi-stranded, dual conductor low voltage wire (sold separately).

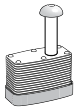

Pin Lock (FM133)

The **Pin Lock** substitutes for the clevis pin at the front end of the **Mighty Mule®** gate operators. Helps prevent theft of the operator from the gate, while allowing quick release of the operator.



Key Chain Two Button Transmitter (FM134)

The Key Chain Mini Transmitter is a miniature version of the **Mighty Mule®** entry transmitter and has the same adjustable code settings. 12 Volt battery included.



Single Button Transmitter (FM135)

The **Mighty Mule®** entry transmitter, with adjustable code settings, is standard equipment with all **Mighty Mule®** systems. 12 Volt battery included.



Digital Keypad (FM137)

The specially designed digital keypad can be easily installed as a wireless or wired keypad. It can be programmed to use up to 25 different personal identification number (PIN) codes. Each code is face programmable with additional security features built in. Wired installations require 16 gauge, low voltage, multi-stranded, dual conductor, direct burial wire (sold separately). Requires 3 AA batteries (not included).



Mounting Post (FM100) - In Ground

This black powder coated pedestal is designed to provide convenient access to your keypad, wireless intercom, or other access control device from your vehicle. With its break down design it is easy to install and works well in most standard applications. Surface Mount Flanges (F102) and Extensions (F103) for added height are available.

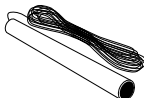

Gate Opening Sensor (FM138)

The **Mighty Mule®** Gate Opening Sensor is designed for residential and agricultural applications and is compatible with all **Mighty Mule®** automatic gate operator models. The wand is an electromagnetic sensor, which offers 'hands free' operation of the **Mighty Mule®** Gate Operators with a 12 ft. radius of detection of vehicles in motion.

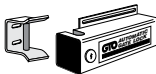

Automatic Gate Lock Pull-to-Open (FM143)

A **MUST** for added security. Solenoid driven, with a steel housing. Unlocks and locks automatically as gates open and close. Used with **Mighty Mule®** DC swing gate operating systems for maximum stability and security. Comes with a keyed manual release. Recommended for gates over 8 ft. long. Ideal for animal enclosures or high wind areas.



Wireless Entry Intercom / Keypad (FM136)

Allows owner to screen guest at the gate before allowing access to the property. Keypad also allows owner to give up to 25 programmable entry codes to family, friends or approved delivery personnel. Codes can be permanent or temporary. Can be wireless up to 500 feet or hard wired up to 1000 feet. Additional base stations available (F3101MBC).

Other Mighty Mule and GTO/PRO Access Controls and Accessories



Replacement Battery (FM150)

Standard 12 volt, 7.0 amp-hour, maintenance-free battery for the **Mighty Mule® FM500 & FM502** gate operator systems. This is the only battery approved for use with the **Mighty Mule® FM500 & FM502** gate operator systems. Life expectancy is 3-5 years.



Low Voltage Wire (RB509)

The 16 gauge, multi-stranded, dual conductor **Low Voltage Wire** is for connecting the AC powered transformer, or the **Solar Panel** to the control board. Also used for the connection of accessories, such as locks, keypads, push buttons and other wired control devices. This specially designed wire is UV treated, PVC coated and ready for direct burial. Available in 50, 100, 250, 500 and 1000 foot rolls.

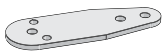

11" Push to Open Bracket (FM148)

Required when **Mighty Mule® 500/502** gate operator(s) must push the gate open, such as on a sloping driveway or where space prevents gate(s) from opening inward (pulled open). Order two PTO brackets for conversion of a dual swing gate installation.



Column Mount Lock Receiver (433IH)

For mounting the **Automatic Gate Lock** on brick columns, walls, or for other applications with limited space between gate and post.

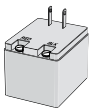

Replacement Transformer (RB570)

Standard 18 volt, 2200 mA, AC transformer for maintaining the battery included with the **Mighty Mule®** gate operator. This is the only transformer approved for use with **all UL325 Mighty Mule®** gate operator systems.

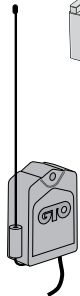

Garage Door Receiver (RB709U)

The Garage Door Receiver allows you to use the same **Mighty Mule®** entry transmitter (see Dual Transmitter) to operate your gate operator and your garage door operator. Compatible with most garage door operators.

**If you have a question about any special order item,
just call 1-800-543-GATE!**



3121 Hartsfield Road • Tallahassee, Florida, USA 32303
Telephone GTO Sales: 1-800-543-GATE (4283) or (850) 575-0176 • Fax (850) 575-8912
or GTO Technical Service: 1-800-543-1236 or (850) 575-4144 • Fax (850) 575-8950
www.gtoinc.com

The contents of all material available on this installation manual are copyrighted by Gates That Open, LLC ("GTO"), unless otherwise indicated. All rights are reserved by GTO, and content may not be reproduced, downloaded, disseminated, published, or transferred in any form or by any means, except with the prior, written permission of GTO. Any reprinting of GTO publications is by permission only. Copyright infringement is a violation of federal law.

Mighty Mule®, E-Z Gate®, GTO®, are registered trademarks of Gates That Open, LLC. America's DIY Automatic Gate Openers is a trademark of Gates That Open, LLC and are the exclusive property of Gates That Open, LLC ("GTO").

All rights are reserved by GTO, and these marks may not be used, in any for without the prior, written permission of GTO.