

MDKP

MEGACODE®

WIRELESS KEYPAD TRANSMITTER

Installation Instructions

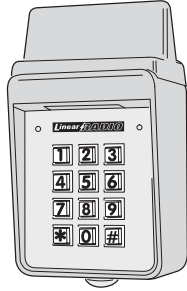

Linear®

(760) 438-7000 • FAX (760) 438-7043
USA & Canada (800) 421-1587 & (800) 392-0123
Toll Free FAX (800) 468-1340
www.linearcorp.com

DESCRIPTION

The MDKP Wireless Keypad is one of Linear's MegaCode® series of wireless radio controls designed for use with automatic garage door and gate operators. The MegaCode radio format provides unparalleled security with more than a million different codes.

In operation, the user enters their unique code (1 to 6 digits long) on the unit's keypad then presses the "#" key to send a signal to the door or gate operator receiver.

The MDKP can be illuminated for use at night or in dark areas. Pressing the "#" key before entering a code turns on two yellow lights that shine down on the keypad's keys. To illuminate the keypad after beginning to enter a code, press the "#" key twice, then re-enter the entire code. The keypad lights remain on for 30-seconds, or until a code is sent.

The option jumper controls two features, the keypad lockout timer and the 30-second repeat feature. The keypad lockout timer will disable the keypad after 10 repeated activations. The keypad must remain idle for 30 seconds before any new code attempts are accepted. The 30-second repeat feature allows the user to press the "#" key again within 30 seconds to send another signal without having to re-enter their code. These features are available only when option jumper is installed. **NOTE: Having the option jumper installed will reduce the unit's battery life.** The MDKP is powered by a 9-volt lithium battery. Without the option jumper installed the battery life is expected to be 5 years with 25 activations-a-day.

MegaCode receivers are programmed by sending a signal from the user's transmitters. This stores the transmitter's code into the receiver's memory. The receiver will only activate from these "memorized" transmitters. Each code entered on the MDKP keypad will appear to the receiver as a unique MegaCode transmitter. MegaCode receivers have limits on the number of transmitters that can be programmed into them. Any combination of portable transmitters and keypad codes up to the maximum number of transmitters allowed can be programmed into a receiver.

1. COMPONENT LOCATIONS

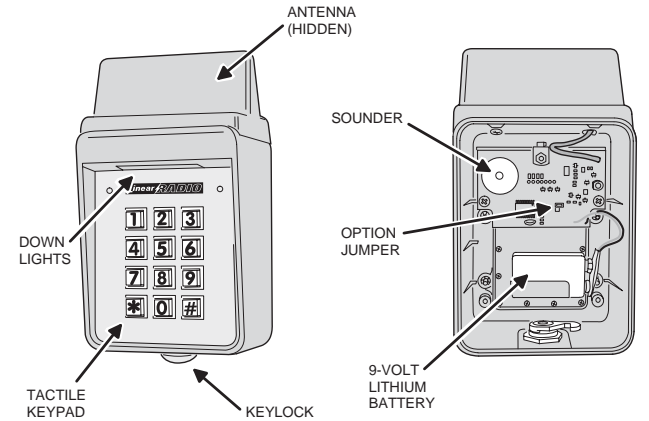

2. KEYPAD MOUNTING

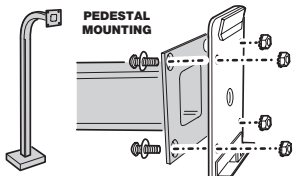

MOUNT BACKPLATE WITH SECURITY BOLTS AND LOCKNUTS

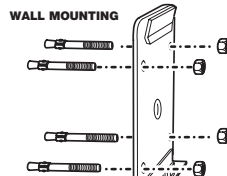

USE CONCRETE WEDGE ANCHORS OR MOLLY ANCHORS

WARNING!



TO AVOID SERIOUS INJURY OR DEATH, MAKE SURE THAT THE UNIT IS FAR ENOUGH FROM THE DOOR OR GATE SO THAT THE USER CANNOT TOUCH THE DOOR OR GATE WHILE OPERATING THE KEYPAD. HOWEVER, THE DOOR OR GATE MUST BE FULLY VISIBLE FROM THE KEYPAD.

3. CONNECT BATTERY

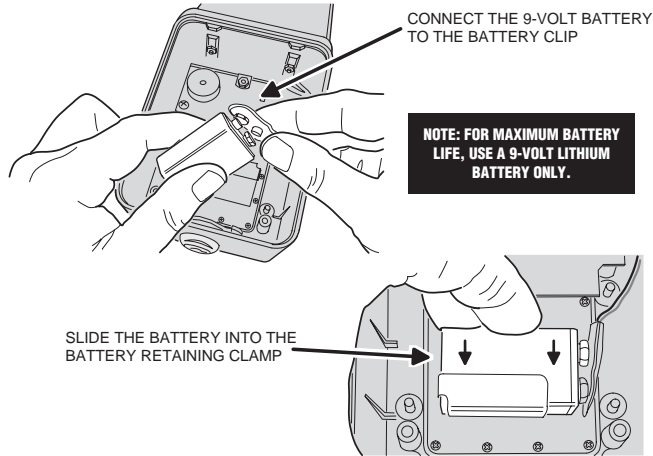

4. SET JUMPER & LOCK KEYPAD

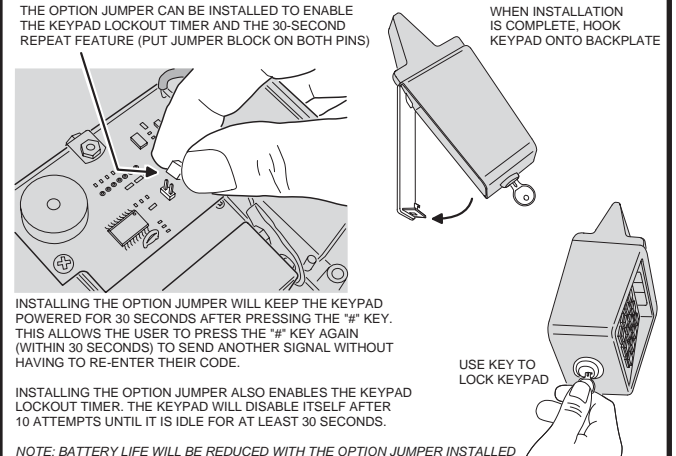

5. PROGRAM RECEIVER

1 REFER TO THE RECEIVER'S INSTRUCTIONS TO PLACE THE RECEIVER INTO PROGRAM MODE



2 ENTER A ONE TO SIX DIGIT CODE

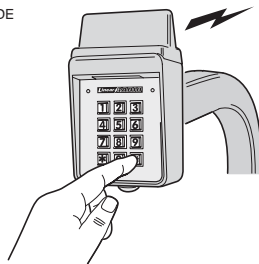

3 PRESS THE "#" KEY TO SEND THE CODE TO THE RECEIVER

4 REPEAT STEPS ONE, TWO, AND THREE TO ADD ADDITIONAL CODES INTO THE RECEIVER'S MEMORY

6. TEST OPERATION

WARNING!
BE SURE DOOR OR GATE AREA IS CLEAR OF OBSTRUCTIONS

TRY EACH KEYPAD CODE

THE DOOR OR GATE OPERATOR SHOULD ACTIVATE WHEN THE "#" KEY IS PRESSED AFTER ENTERING A VALID KEYPAD CODE

IN THESE EXAMPLES, THE USER'S SECRET CODE IS: 1, 2, 3

DAYTIME OPERATION:

PRESS: 1 → 2 → 3 → #
USER'S SECRET CODE SEND

NIGHTTIME OPERATION:

PRESS: # → 1 → 2 → 3 → #
LIGHTS KEYPAD USER'S SECRET CODE SEND



TO CLEAR KEYPAD AT ANY TIME:
PRESS: # → #

LINEAR LIMITED WARRANTY

This Linear product is warranted against defects in material and workmanship for twelve (12) months. The Warranty Expiration Date is labeled on the product. **This warranty extends only to wholesale customers** who buy direct from Linear or through Linear's normal distribution channels. **Linear does not warrant this product to consumers.** Consumers should inquire from their selling dealer as to the nature of the dealer's warranty, if any. **There are no obligations or liabilities on the part of Linear Corporation for consequential damages arising out of or in connection with use or performance of this product or other indirect damages with respect to loss of property, revenue, or profit, or cost of removal, installation, or reinstatement.** All implied warranties, including implied warranties for merchantability and implied warranties for fitness, are valid only until Warranty Expiration Date as labeled on the product. **This Linear Corporation Warranty is in lieu of all other warranties express or implied.**

All products returned for warranty service require a Return Product Authorization Number (RPA#). Contact Linear Technical Services at 1-800-421-1587 for an RPA# and other important details.

IMPORTANT!

- For U.S. installations only: The radios are required to comply with FCC Rules and Regulations as Part 15 devices. As such, they have limited transmitter power and therefore limited range.
- A receiver cannot respond to more than one transmitted signal at a time and may be blocked by radio signals that occur on or near their operating frequencies, regardless of code settings.
- Changes or modifications to the device may void FCC compliance.
- Infrequently used radio links should be tested regularly to protect against undetected interference or fault.
- A general knowledge of radio and its vagaries should be gained prior to acting as a wholesale distributor or dealer, and these facts should be communicated to the ultimate users.